



HARVESTING RAINWATER

FOR LANDSCAPE USE

PATRICIA H. WATERFALL
Extension Agent, University of Arizona
Cooperative Extension/Low 4 Program

Second Edition, October 2004
Revised 2006

Cooperative Extension
College of Agriculture and Life Sciences
The University of Arizona
Tucson, AZ 85721

Second Edition, October 2004/Revised 2006 • AZ1344

Issued in furtherance of Cooperative Extension work, acts of May 8 and June 30, 1914, in cooperation with the U.S. Department of Agriculture, James A. Christenson, Director, Cooperative Extension, College of Agriculture & Life Sciences, The University of Arizona.

The University of Arizona is an equal opportunity, affirmative action institution. The University does not discriminate on the basis of race, color, religion, sex, national origin, age, disability, veteran status, or sexual orientation in its programs and activities.

Any products, services, or organizations that are mentioned, shown, or indirectly implied in this publication do not imply endorsement by the University of Arizona, or the Arizona Department of Water Resources.

HARVESTING RAINWATER FOR LANDSCAPE USE

**First Edition by
Patricia H. Waterfall, Extension Agent -retired
Pima County Cooperative Extension, Low 4 Program**

**Second Edition prepared by
Christina Bickelmann, Water Conservation Specialist,
Arizona Department of Water Resources, TAMA**

Artwork prepared by Silvia Rayces unless otherwise indicated
Cover Design - Christina Bickelmann, ADWR
Culvert Cistern Detail - Scott Calhoun, Josephine Thomason
Large Cistern Detail - Heather Kinkade-Levario

Second edition editorial assistance from

Consortium for Action Throughout the Community for Harvesting
Water (CATCH Water) - Jim Riley, University of Arizona,
Soil, Water and Environmental Science Dept.

Production assistance — ECAT,
University of Arizona College of Agriculture and Life Sciences

Project funding and support from
The Water Management Assistance Program
Tucson Active Management Area
Arizona Department of Water Resources

Document may be ordered from the Arizona Department of
Water Resources, Tucson Active Management Area,
400 W. Congress, Suite 518, Tucson AZ 85701,
Phone (520) 770-3800 Fax (520) 628-6759
Visit our website at: www.azwater.gov

CONTENTS

INTRODUCTION	1
WATER HARVESTING SYSTEM COMPONENTS	4
SIMPLE WATER HARVESTING SYSTEM DESIGN AND CONSTRUCTION	9
COMPLEX WATER HARVESTING SYSTEMS	12
Elements of a Complex Water Harvesting System	14
Complex System Design and Construction	18
Calculating Supply	19
Calculating Demand	21
Calculating Storage and Municipal Water Requirement	27
Final Design and Construction	29
APPENDICES	32
Appendix A - Guidelines for Gutters and Downspouts	32
Appendix B - Roof Washing System, First Flush Device	33
Appendix C - Residential Cistern Detail	34
Appendix D - Culvert Cistern Detail	35
Appendix E - Worksheet #1 Supply Calculations	40
Appendix F - Worksheet #2 Demand Calculations (Method 1) ..	41
Appendix G - Worksheet #3 Demand Calculations (Method 2) .	42
Appendix H - Worksheet #4 Storage and Municipal Use	43
Appendix I - Rainfall Data for Arizona Cities and Towns	44
Appendix J - Evapotranspiration for AZ Cities and Towns	47
Appendix K - Related Resources and Contacts	50

INTRODUCTION

Historically, harvested rain water provided water for drinking, landscape watering, and for agricultural uses. Once urban areas started to develop, centralized water supply systems replaced the need to harvest water. More recently, people have become reacquainted with water harvesting, using it to provide water for residential and commercial landscapes.

Harvesting rainwater can reduce the use of drinking water for landscape irrigation. It is also an effective water conservation tool and proves more beneficial when coupled with the use of native, low-water-use and desert-adapted plants. Additionally, rainwater is available free of charge and puts no added strain on the municipal supply or private wells.

Throughout Arizona and the arid Southwest, annual and seasonal precipitation varies widely and is often scarce when plant water requirements are high during the summer months. In the desert regions of Arizona, approximately half of the annual rain falls in winter, the remainder during the summer monsoons. At higher elevations, in addition to the monsoons, winter precipitation may come in the form of snow providing opportunities for water harvesting when it melts.

The Phoenix and Tucson areas receive an average of 8 and 12 inches of annual rainfall, respectively. Along the Colorado River, cities such as Yuma and Bullhead City receive only 3 to 6 inches. At higher elevations annual rainfall varies from as low as 15 inches to as high as 23 inches. Only native and some plants that can flourish in our soils and climate can live on the annual rainfall received. Plants from non-arid climates require a great deal of supplemental irrigation.

There are many water harvesting opportunities on developed sites and it can easily be planned into a new landscape during the design phase. Homes, schools, parks, parking lots, apartment complexes, and commercial facilities all provide sites where rainfall can be harvested. Even very small yards can benefit from water harvesting. Whether your landscape is large or small, the principles outlined in this manual apply.

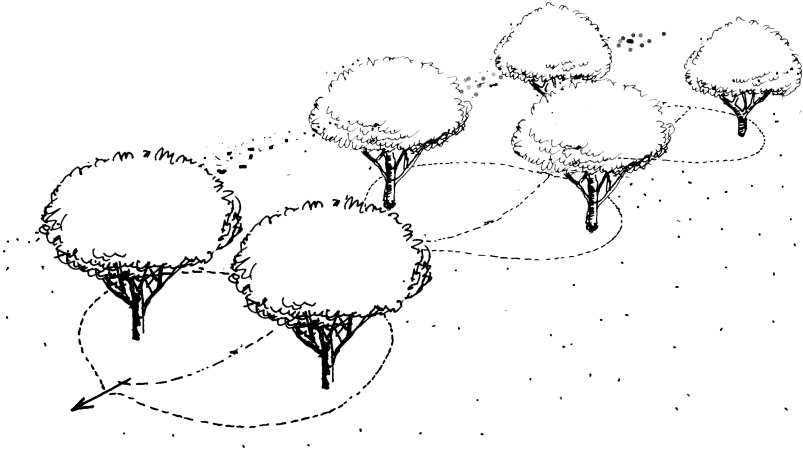

Series of planted water harvesting basins on a slope.

Water harvesting is the capture, diversion, and storage of rainwater for plant irrigation and other uses. It is appropriate for large scale landscapes such as parks, schools, commercial sites, parking lots, and apartment complexes, as well as small scale residential landscapes.

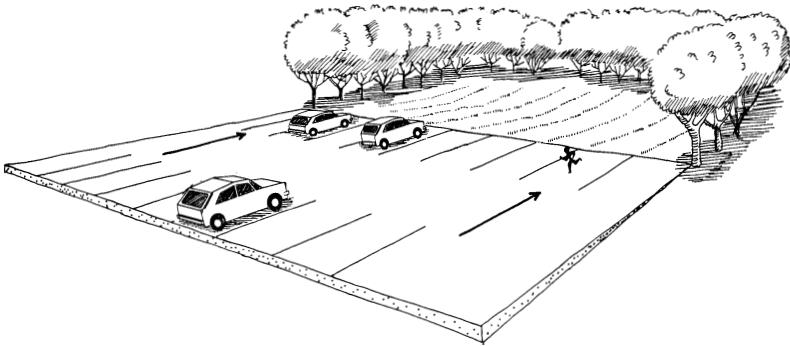

Parking lot draining into concave lawn area.

Many methods are available to harvest rain water for landscape use, some of them inexpensive and easy to construct. An example would be storing water in a barrel for later use or constructing small berms and drainages to direct water to a row of trees. Even the simplest methods provide benefits. The water customer's bill is lowered and the community receives long-term benefits from reduced water use and less soil erosion. All you need to get started is rainfall and plants that require irrigation.

There are many benefits to harvesting rainwater:

- ◆ Water harvesting not only reduces potable water use and related costs, but also reduces off-site flooding and erosion by holding rainwater on the site.
- ◆ If large amounts of water are held in pervious areas where water penetrates easily, some of the water may percolate to the water table.
- ◆ Rainwater is a clean, salt-free source of water for plants.
- ◆ Rainwater harvesting can reduce salt accumulation in the soil which can be harmful to root growth. When collected, rainwater percolates into the soil, forcing salts down and away from the root zone area. This allows for greater root growth and water uptake, which increases the drought tolerance of plants.
- ◆ Limitations of water harvesting are few and are easily met by good planning and design.

WATER HARVESTING SYSTEM COMPONENTS

A rainwater harvesting system has three components: the supply (rainfall), the demand (landscape water requirement), and the system that moves the water to the plants. Storage is an additional element which is optional.

Rainfall. Rainwater runoff refers to rainwater which flows off a surface. If the surface is impervious (water cannot penetrate it), then runoff occurs immediately. If the surface is pervious (water can penetrate it), then runoff will not occur until the surface is saturated. Runoff can be harvested (captured) and used immediately to water plants or can be stored for later use. Several factors affect runoff, the most important being the *amount* of rainfall. Rainfall *duration* refers to the length of time the rain falls, the longer the duration, the more water available to harvest. The *intensity* of the rainfall affects how soon the water will begin to run off and also how fast it runs off. The harder it rains and the longer it lasts the more water there is for harvesting. The *timing* of the rainfall is also important. If only one rainfall occurs, water percolates into the dry soil until it becomes saturated. If a second rainfall occurs soon after the first, more water may runoff because the soil is already wet.

Plant Water Requirement. The type of plants selected, their age and size, and how closely together they are planted all affect how much water is required to maintain a healthy landscape. Because rainfall is scarce in arid regions, it is best to select plants with low water requirements and control planting densities to reduce overall water need. Native plants are well-adapted to seasonal, short-lived water supplies, and most desert-adapted plants can tolerate drought, making them good choices for landscape planting.

Water Collection and Distribution System. Water harvesting systems range from simple to complex. In a simple system the rainwater is used immediately. Most homeowners can design simple water harvesting systems to meet the needs of their existing site. Designing water harvesting systems into new construction allows the homeowner to be more elaborate and thorough in developing a system. In the case of very simple systems, the pay back period may be almost immediate.

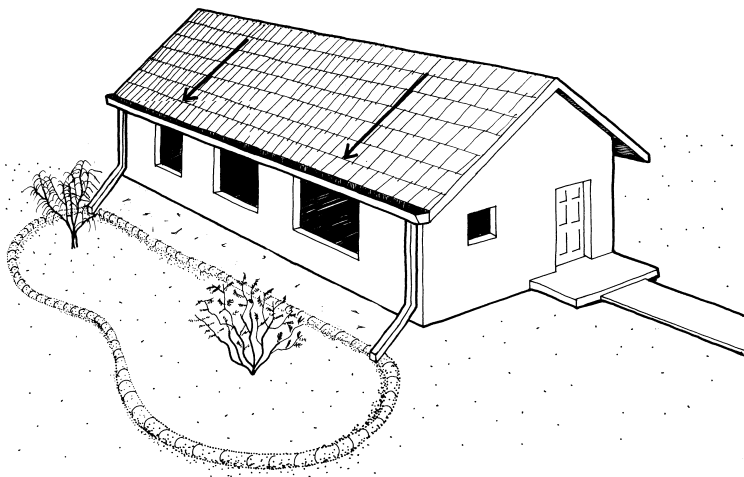

Simple system — Roof catchment, gutters, downspouts and bermed landscape holding area.

A simple system usually consists of a *catchment area*, and a means of *distribution*, which operates by gravity. The water is deposited in a *landscape holding area*, a concave area or planted area with “edges” to retain water, where it can be used immediately by the plants.

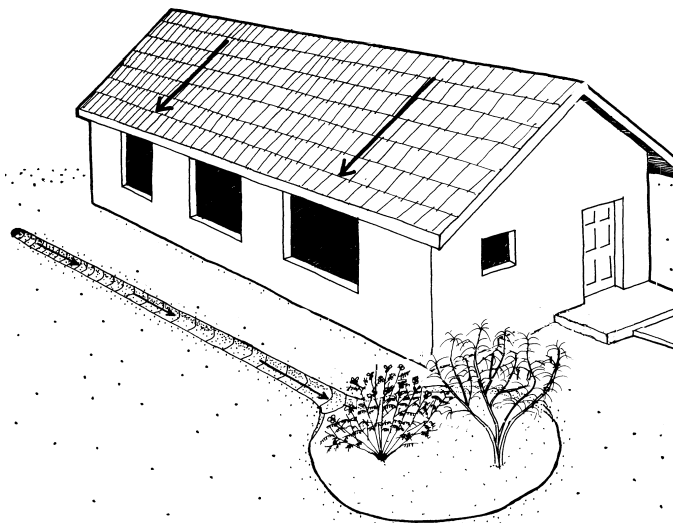

Simple system — Roof catchment, channel and planted landscape holding area.

A good example of a simple system is water dripping from the edge of the roof to a planted area or diversion channel directly below. Gravity moves the water to where it can be used. In some cases, small containers are used to hold water for later use.

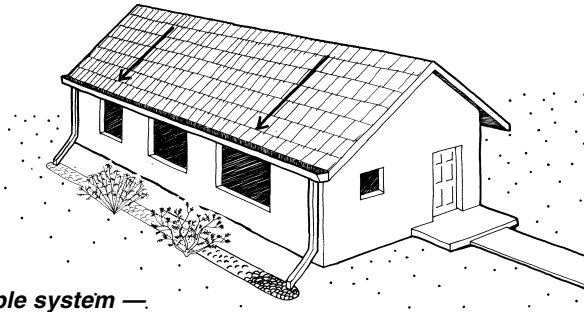

**Simple system —
Roof catchment, gutters, downspouts and french drain.**

A *catchment area* is any area from which water can be harvested. Water collects on roofs, paved areas or the soil surface. The best catchments have hard smooth surfaces, such as concrete or metal roofing material. The amount of water harvested depends on the size, surface texture, and slope of the catchment area.

The *distribution system* connects the catchment area to the landscape holding area. Distribution systems direct water flow, and can be very simple or very sophisticated. For example:

- ◆ Gutters and downspouts direct roof water to a holding area, and gently sloped sidewalks distribute water to a planted area.
- ◆ Hillsides provide a perfect situation for moving water from a catchment area to a holding area.
- ◆ Channels, ditches, and swales all can be utilized to move water. Elaborate open channel distribution systems may require gates and diverters to direct the water from one area to another.
- ◆ Standard or perforated pipes and drip irrigation systems can be designed to distribute water.
- ◆ Curb cutouts can channel street or parking lot water to planted areas. If gravity flow is not possible, a small pump may be required to move the water.

Landscape holding areas store water in the soil for direct use by the plants. Concave depressions planted with grass or plants serve as landscape holding areas, containing the water, increasing water penetration, and reducing flooding. Depressed areas can be dug out, and the extra soil used to berm (a bank of soil used to retain water) the depression. With the addition of berms, moats, or soil terracing, flat areas also can hold water. One holding area or a series of holding areas can be designed to fill and then flow into adjacent holding areas via spillways (outlets for surplus water).

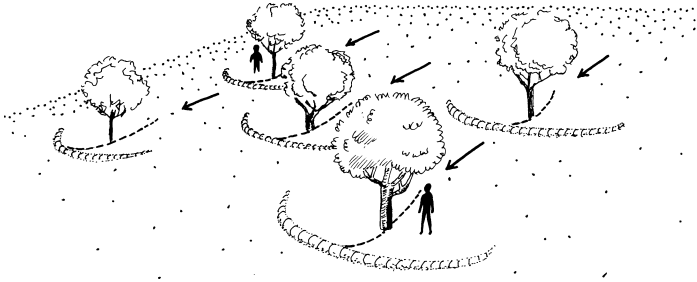

Crescent-shaped landscaped holding areas on a slope.

Soil erosion can be a problem with water moving quickly over the soil surface. Basins and spillways help reduce this. Crescent-shaped berms constructed around the base of the plant on the downhill side are useful on slopes for slowing and holding water.

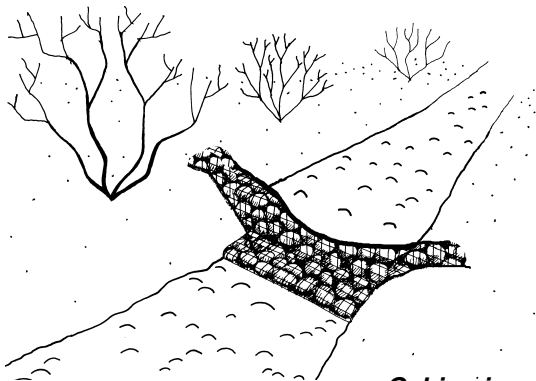

Gabion in a stream bed.

Gabions (a stationary grouping of large rocks encased in wire mesh) are widely used to contain water and reduce erosion. A trench is dug at least 12 inches deep across the wash, wire mesh is laid in the trench with the rocks to prevent undercutting.

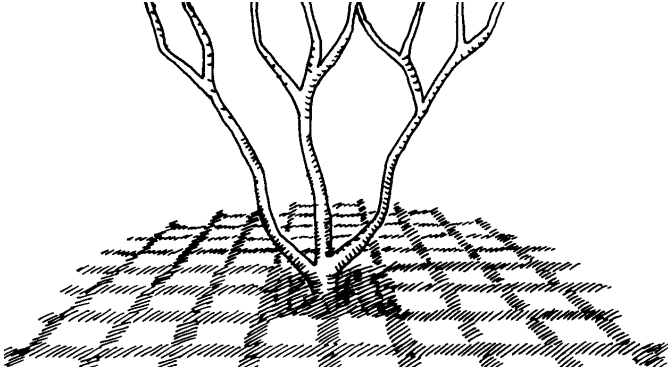

Pervious paving block with grass.

French drains (holes or trenches filled with gravel) can also hold water for plant use. And lastly, pervious paving materials, such as gravel, crushed stone, open paving blocks, and pervious paving blocks, allow water to infiltrate into the soil to irrigate plants with large, extensive root systems, such as trees.

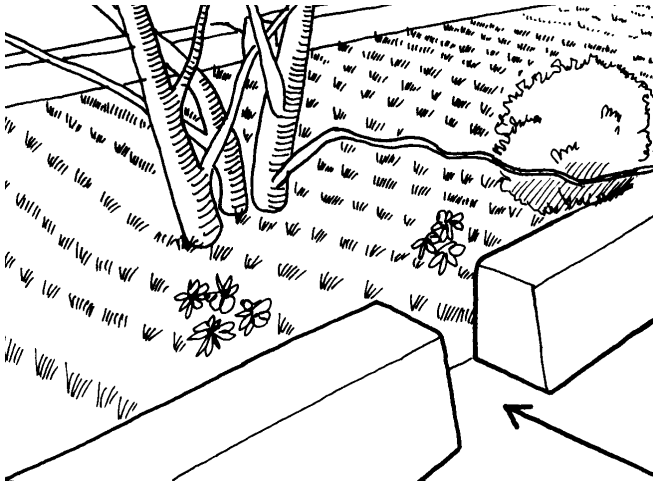

Parking lot curb cutout directing water into planted area.

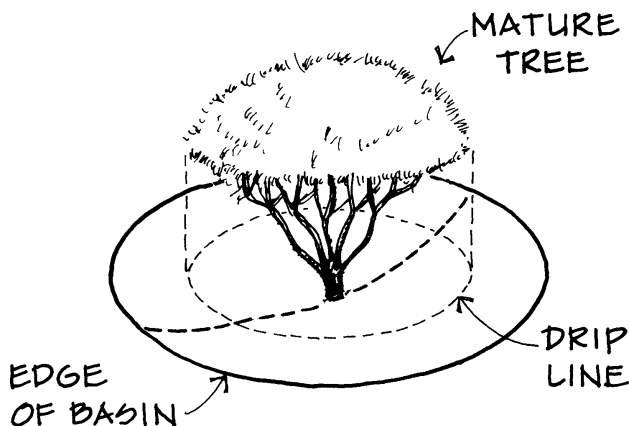

Tree drip line and basin edge.

Holding areas around existing plants should extend beyond the “drip line” to accommodate and encourage extensive root systems. The more developed a plant’s root system, the more drought tolerant the plant becomes because the roots have a larger area to find water. For new plantings, locate the plants at the upper edge of concave holding areas to encourage extensive rooting and to avoid subjecting the roots to extended inundation (flooding). With either existing or new landscapes you may want to connect several holding areas with spillways or channels to distribute the water throughout the site.

To take advantage of water free-falling from roof downspouts (canales) plant large rigid plants where the water falls or hang a large chain from the downspout to the ground to disperse and slow the water. Provide a basin to hold the water for the plants and also to slow it down. It may be necessary to use rocks or other hard material to break the fall and prevent erosion. If it is a sloped site, large, connected, descending holding areas can be constructed for additional plants.

Selecting Plant Material. A major factor in the success of a water harvesting project is proper plant selection. Native and desert-adapted plants can be grown successfully using harvested rainwater for irrigation. Some plants cannot survive in the detention area if in clay soil that is repeatedly saturated over a long period of time. Select native plants or plants adapted to your local climate that can withstand prolonged drought and prolonged inundation. If plants are going to be planted in the bottom of large, deep basins, low water use, native riparian trees may be the most appropriate choice (hackberry, desert willow, acacia, mesquite).

Seeding is another planting alternative for holding basins. Select seed mixes containing native or desert-adapted wildflowers, grasses, and herbaceous plants. Consider annual plants for instant color and perennial plants for extended growth. Perennial grasses are particularly valuable for holding the soil in place and preventing erosion.

Construction Hints. If you are going to dig, particularly if you are going to be using a bobcat, small tractor, or rototiller, call Arizona Blue Stake (1-800-782-5348) to locate where utility lines come into your property. This will eliminate leaks and breaks. Even if you are constructing a simple system with a rake and shovel, be aware of utility line locations.

Soils in the landscape holding areas should not be compacted because this inhibits the water moving through the soil, if it is, loosen it by tilling. If the soil is too sandy and will not hold water for any length of time, you may wish to add composted organic matter to the soil to increase moisture holding potential (This is not necessary with native or desert-adapted plants). After planting apply a 2 1/2 – 3 inch layer of mulch to the surface to reduce evaporation.

**TABLE - 1
MAINTENANCE CHECKLIST**

Keep holding areas free of debris.

Control and prevent erosion, block erosion trails.

Clean, repair channels.

Clean, repair dikes, berms, moats.

Keep gutters and downspouts free of debris.

Flush debris from the bottom of storage containers, if possible.

Clean and maintain filters, including drip filters.

Expand the area of concentration as plants grow.

System Maintenance. Water harvesting systems are always in a state of “construction.” Developing a water harvesting system is actually an ongoing process that can be improved and expanded over time. Water harvesting systems should be inspected before each rainy season and ideally after every rain event to keep the system operating at optimum performance. Make a habit of observing your system during rain events to determine whether the water is moving where you want it, or whether you are losing water that could be captured. Also determine if the holding areas are doing a good job of containing the water. Make changes and repairs as your system requires. As time goes on you may discover additional areas where water can be harvested and where water can be channeled.

Monitor Water Use. Now that you have your system operating, it is a good idea to monitor your landscape water use. If you have constructed water harvesting basins in an existing landscape, use last year's water bills to compare your pre-water harvesting use to your post-water harvesting use. If you have added new plants to a water harvesting area, the water savings begins when they are planted. Every time they can be irrigated with harvested rainwater there is a water savings!

COMPLEX WATER HARVESTING SYSTEMS

Water harvesting cannot provide a completely dependable source of irrigation water because it is dependent on the weather, and weather is not dependable. To get the maximum benefit from rainwater harvesting, some storage can be built into the water harvesting system to provide water between rainfall events. In Southern and Central Arizona there are two rainy periods (summer and winter) with long dry periods between the two. Heavy rainfall can produce more water than can be utilized by a landscape during that rainfall event. Once the root zone of the plants have been thoroughly wetted, the rainwater begins to move below the root zone. At this point plants are well irrigated. As the soil becomes saturated, water begins to run off or stand on the surface. The saturation point and the onset of runoff is dependent on the texture and condition of the soil. For instance, sandy soils accept more water than clayey soils before runoff occurs.

Many people ask whether they can harvest enough water in an average year to provide sufficient irrigation for an entire landscape, it depends. If you are interested in designing a totally self-sufficient water harvesting system, then the amount of water harvested and the water needed for landscape irrigation should be in balance. Storage capacity plays a big role in this equation by making rainwater available in the dry seasons when the plants need it.

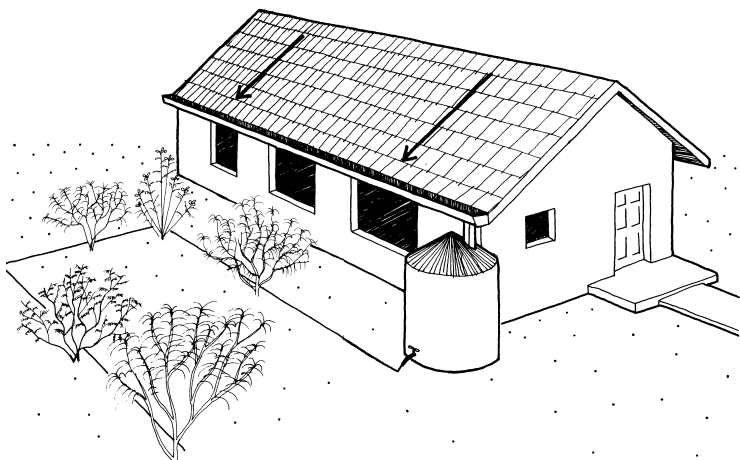

Complex water harvesting system with roof catchment, gutter, downspout, storage, & drip irrigation distribution system.

Rainfall harvesting systems that utilize storage result in both larger water savings and higher construction costs. These more complex systems can be constructed for homes or for larger facilities but may require professional assistance to design and construct. With such a system the cost of storage, particularly the disposal of soil and rock from underground storage construction, is a major consideration. However, soil and rock from storage construction could be used for raising paths and other areas so water would run off into low lying areas or used for berms to hold water, increasing water harvesting on the site and reducing removal costs.

Is the cost of storage greater than the cost of water? In many cases, yes. In this case the personal commitment to a “water conservation ethic” may come into play. A more realistic goal, and one that is followed by most people is to harvest less than the total landscape requirement. Another option is to reduce your demand by reducing the number and size of your planting areas or plant densities. This involves less storage and is therefore less expensive.

Elements of a Complex Water Harvesting System

Components of complex systems that utilize storage include *catchment areas*, usually a roof, *conveyance systems*, *storage*, and *distribution systems* to control where the water goes. The amount of water or “*yield*” that the catchment area will provide depends on the size of the catchment area and its surface texture. Catchment areas made of concrete, asphalt, or brick paving and smooth-surfaced roofing materials provide high yields. Bare soil surfaces provide harvests of medium yield. Of all the soil types, compacted clayey soils have the highest yield. Planted areas, such as grass or groundcover areas offer the lowest yields because the plants hold the water longer allowing it to infiltrate into the soil. This is not necessarily a problem, depending whether you want to use collected water immediately in planted areas, or store it for later use.

TABLE - 2
RUNOFF COEFFICIENTS

	HIGH	LOW
ROOF		
Metal, gravel, asphalt, shingle, fiber glass, mineral paper	0.95	0.90
PAVING		
Concrete, asphalt	1.00	0.90
GRAVEL	0.70	0.25
SOIL		
Flat, bare	0.75	0.20
Flat, with vegetation	0.60	0.10
LAWNS		
Flat, sandy soil	0.10	0.05
Flat, heavy soil	0.17	0.13

Conveyance systems. With a roof catchment system the gutter and downspouts are the means of conveyance that direct the water from the catchment area to the storage container. Gutters and downspouts are either concealed inside the walls of buildings or attached to the exterior of buildings. They can be added to the outside of a building at any time. Proper sizing of gutters is important to collect as much rainfall as possible. (See Guidelines, Appendix A)

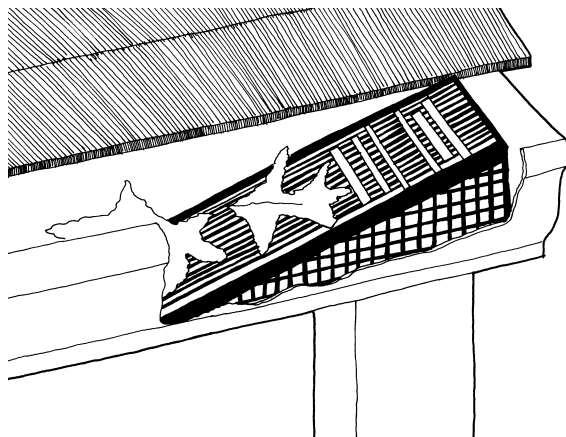

Gutter drain filter.

Before the water is stored it should be filtered to remove particles and debris. The degree of filtration is dependent on the size of the distribution tubing (drip systems would require more and finer filtering than water distributed through a hose). Filters can be in-line or a leaf screen can be placed over the gutter at the top of the downspout.

Many people divert the first part of the rainfall to eliminate debris from the harvested water. The initial rain “washes” debris off the roof, the later rainfall, which is free of debris and dust, is then collected and stored. The simplest roof-washing system consists of a standpipe and a gutter downspout located ahead of the cistern (Appendix B). The standpipe is usually 6-8 inch PVC equipped with a valve and a clean-out at the bottom. Once the first part of the rainfall fills the standpipe, the rest flows to the downspout connected to the cistern. After the rainfall, the standpipe is drained in preparation for the next rain event. Roof-washing systems should be designed so that at least 10 gallons of water are diverted to the system for every 1,000 square feet of collection area. Several types of commercial roof washers are also available.

Storage. By making water available later when it is needed allows full utilization of excess rainfall. Locate storage near downspouts or at the end of the downspout. Storage can be underground or above-ground. Storage containers can be made of polyethylene, fiberglass, wood, or metal. Examples of above ground containers include large garbage cans, 55-gallon plastic or steel drums, barrels, tanks, cisterns, stock tanks, fiberglass fishponds, storage tanks, and above ground swimming pools.

Above ground storage buildings or large holding tanks made of concrete block, stone, plastic bags filled with sand, or rammed earth can also be used. Swimming pools, stock tanks, septic tanks, ferrocement culverts, concrete block, poured in place concrete, or building rock can be used for underground storage. Look in the Yellow Pages under "Tanks," "Feed Dealers," "Septic Tanks," and "Swimming Pools" to locate storage containers.

Containers should be opaque and, if possible, shielded from direct sunlight to prevent algae growth. Storage containers should be covered to prevent mosquito breeding and debris from getting into the storage container, secured from children and clearly labeled as unfit for drinking. Regular inspection and maintenance (cleaning) are essential.

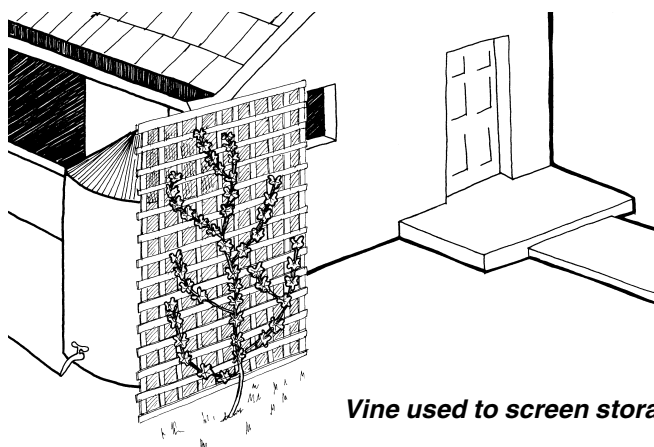

Vine used to screen storage tank.

If storage is unsightly, it can be designed into the landscape by placing it in an unobtrusive place or hiding it with a structure, screen, and/or plants. Storage should be located close to the area of use and placed at an elevated level to take advantage of gravity flow. In all cases, cisterns should be placed a minimum of four to six feet away from the foundation in case of leaks. Ideally, on a sloped lot the storage area is located at the high end of the property to facilitate gravity flow.

It is important to have an overflow pipe taking excess water away from the tank when it is full. The overflow pipe should be set an inch or so below the lip of the cistern so the water goes through the overflow pipe instead of spilling over the lip of the cistern. Some times it is more useful to locate several smaller cisterns near where water is required because they are easier to handle and camouflage.

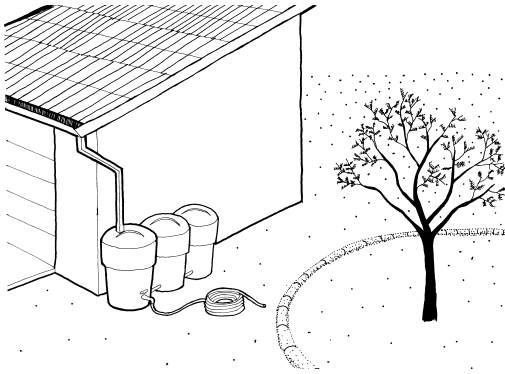

Roof catchment with multiple storage cans connected to a hose adjacent to a landscape holding area.

If the landscaped area is extensive, several tanks can be connected to increase storage capacity. In the case that all storage tanks become full and rainfall continues, alternative storage for the extra water must be found. A concave lawn area would be ideal as a overflow holding area allowing the rain water to slowly percolate into the soil.

Estimates for the cost of storage ranges from \$100 to \$3,500 depending on the system, degree of filtration, and the distance between the storage and the place of use. Underground containers are a more expensive choice because of the cost of soil excavation and removal. Pumping the water out of the container adds an additional cost. *Source: California Department of Water Resources, Captured Rainfall: Small-Scale Water Supply Systems, Bulletin 213. May 1981.*

The distribution system. The distribution device can be a hose, constructed channels, pipes, perforated pipes, or a manual drip system that directs the water from the storage containers to landscaped areas. Gates and diverters can be used to control flow rate and flow direction. A manual valve or motorized ball valve located near the bottom of the storage container can assist gravity fed irrigation.

If gravity flow is not possible, an in-line electric pump hooked to a hose can be used. The distribution of water through an automatic drip irrigation system requires extra effort to work effectively. A small submersible pump will be required to provide enough pressure to activate the remote control valve (minimum 20 psi). To avoid burning the pump out, it should have the capability of turning off when there is no water in the tank.

Complex Water Harvesting System Design & Construction

If you are designing a complex water harvesting system, one that includes storage to provide rainwater in between rainfall events, design your system on paper before constructing it to save time and effort. You may not want to do any calculations, but if you do, a more functional and efficient system will result.

The steps involved in designing a complex water harvesting system include *site analysis*, *calculation*, *design*, and *construction*. If the project is complicated, either because of its size or because it has numerous catchments and planting areas, divide the site into sub-drainage areas and repeat the following steps for each subarea. As a final step field test the system.

Site Analysis. Whether you are starting with a new landscape or working with an existing one, draw your site and all the site elements to scale, then:

- ◆ Plot the existing drainage flow patterns by observing your property during a rain. Show the direction of the water flow with arrows. Indicate high and low areas on your plan.
- ◆ Look for catchment areas to harvest water; for example, paved areas, roof surfaces, and bare earth.
- ◆ Find planted areas or potential planting areas that require irrigation.
- ◆ Locate above or below ground storage near planted areas.
- ◆ Decide how you are going to move water from the catchment area to the holding area or storage container. To reduce costs rely on gravity to move water whenever you can.
- ◆ Decide how you are going to move the water through the site from one landscaped area to another landscaped area. Again, if the site is too large or the system too complicated divide the area into sub-drainage systems.

Calculate supply. First calculate the monthly supply (rainfall harvest potential) and the monthly demand (plant water requirement) for a year. If you are designing a more complex system you will also need to calculate your monthly storage requirement.

The runoff coefficient tells what percent of the rainfall can be harvested from specific surfaces (**TABLE-2**). The higher numbers represent a smoother, less absorbent surface, therefore, greater rainwater collection potential than the lower numbers.

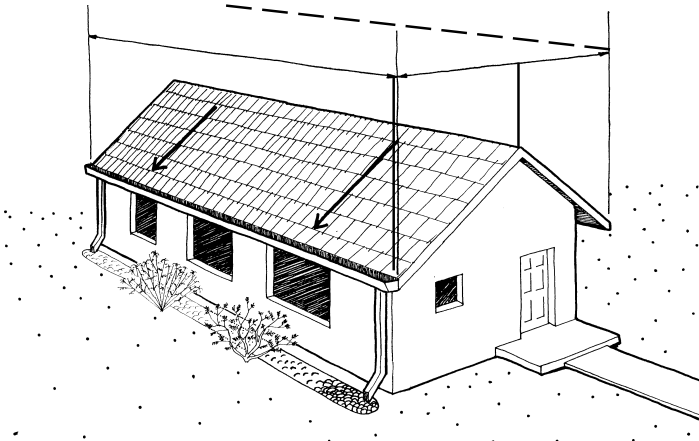

Area of sloped roof — (both sides) Length x width.

The equation for calculating supply measures the amount of water (in gallons) capable of being harvested from a catchment area. The area of the catchment is expressed in square feet, for example a 20' x 50' catchment area equals 1,000 square feet (SF). Measure a sloped roof by measuring the area that is covered by the roof, (both sides).

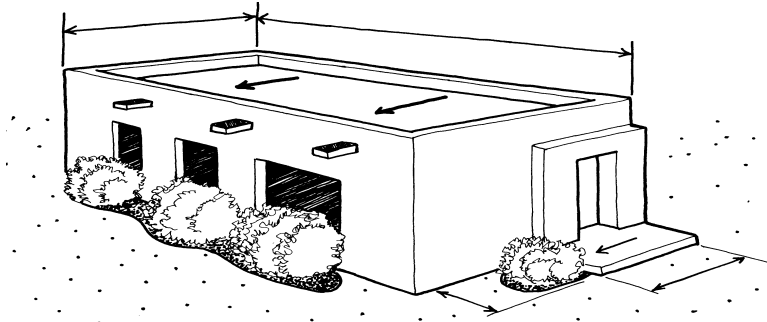

Area of flat roof — Length x width.

For flat roofs measure the length and width of the building. The square footage of the catchment area is multiplied by the amount of rainfall in inches (**TABLE-3**) converted to gallons to get the volume of water.

$$\text{SUPPLY (in Gallons)} = \text{RAINFALL (inches)} \times 0.623 \times \text{CATCHMENT AREA (FT}^2\text{)} \times \text{RUNOFF COEFFICIENT}$$

**TABLE - 3
ANNUAL SUPPLY
FROM ROOF CATCHMENT**

Inches/Rainfall	Gallons/Square Foot
0	.0
1	.6
2	1.3
3	1.9
4	2.5
5	3.1
6	3.7
7	4.4
8	5.0
9	5.6
10	6.2
11	6.8
12	7.5
13	8.1
14	8.7
15	9.3

TABLE - 4
AVERAGE MONTHLY RAINFALL
Tucson and Phoenix

TUCSON, ARIZONA			PHOENIX, ARIZONA		
Month	Inches	Feet	Month	Inches	Feet
JAN	1.0	0.1	JAN	0.9	0.1
FEB	0.9	0.1	FEB	0.8	0.1
MAR	0.7	0.1	MAR	0.9	0.1
APR	0.3	0.0	APRIL	0.3	0.0
MAY	0.2	0.0	MAY	0.2	0.0
JUN	0.4	0.0	JUNE	0.1	0.0
JUL	2.0	0.2	JULY	0.9	0.1
AUG	2.3	0.2	AUG	1.0	0.1
SEPT	1.5	0.2	SEPT	0.7	0.1
OCT	1.2	0.1	OCT	0.8	0.1
NOV	0.8	0.1	NOV	0.8	0.1
DEC	1.0	0.1	DEC	0.9	0.1
TOTAL	12.3	1.0		8.3	0.9

To assist you in calculating your landscape supply and demand, blank worksheets have been provided in Appendices E and F. A sample supply worksheet using Tucson rainfall has been provided (page 22) to show how monthly rainfall amounts are calculated based on 1,000 SF of roof area.

Calculating demand. The demand equation tells you how much water is required for a given landscaped area. There are two methods you can use — **Method 1** is used for new or established landscapes, **Method 2** can only be used for established landscapes.

METHOD 1: The equation for calculating demand for new or established landscapes is based on monthly evapotranspiration (ET_o) information.

ET_o is an estimate of the water lost when a plant transpires or “sweats” through its leaves plus the water evaporated from the soil surface. ET_o provides a useful reference point when determining plant irrigation need. This value is always a percent of ET_o and varies according to the plant species.

SAMPLE SUPPLY WORKSHEET- Tucson

	A	B	C	D	E	F
Follow instructions A through F for each month.	From Table - 4 enter the rainfall amount in inches for each month.	Multiply "A" by 0.623 to convert inches to gallons per square foot.	Enter the square footage of the catchment surface.	Multiply "B" By "C." This is the gross gallons of rainfall per month	Enter the runoff coefficient for your catchment surface (page 14)	Multiply "D" by "E." This is the total monthly yield of harvested water in gallons
January	0.99	0.616	1000	617	0.90	555
February	0.88	0.548	1000	548	0.90	493
March	0.81	0.504	1000	505	0.90	454
April	0.28	0.174	1000	174	0.90	157
May	0.24	0.149	1000	150	0.90	135
June	0.24	0.149	1000	150	0.90	135
July	2.07	1.289	1000	1290	0.90	1161
August	2.30	1.432	1000	1430	0.90	1287
September	1.45	0.903	1000	903	0.90	813
October	1.21	0.753	1000	754	0.90	678
November	0.67	0.417	1000	417	0.90	376
December	1.03	0.641	1000	642	0.90	578
Totals	12.19			7580		6822

TABLE - 5
STANDARDIZED MONTHLY Ref. ET_o
Tucson and Phoenix (Average for 1971- 2000)

TUCSON, ARIZONA			PHOENIX, ARIZONA		
Month	Inches	Feet	Month	Inches	Feet
JAN	2.52	0.21	JAN	2.38	0.20
FEB	3.19	0.27	FEB	2.87	0.24
MAR	5.07	0.42	MAR	4.66	0.39
APR	6.82	0.57	APR	6.38	0.53
MAY	8.61	0.72	MAY	8.71	0.73
JUN	9.59	0.80	JUN	9.39	0.78
JUL	8.95	0.75	JUL	9.02	0.75
AUG	7.75	0.65	AUG	8.28	0.69
SEPT	6.68	0.56	SEPT	6.60	0.55
OCT	4.96	0.41	OCT	4.59	0.38
NOV	3.02	0.25	NOV	2.75	0.23
DEC	2.16	0.18	DEC	2.24	0.19
TOTAL	69.32	5.78	TOTAL	67.87	5.66

In Tucson the average historical ET_o rate is approximately 69 inches and average rainfall is 12 inches. In Phoenix average historical ET_o is approximately 68 inches and average rainfall is 8 inches. **TABLE 5** provides ET_o information for Tucson and Phoenix. Evapotranspiration rates for many additional towns and cities in Arizona are listed in Appendix I, or may be available from AZMET (520) 621-9742 or <http://ag.arizona.edu/azmet/>.

DEMAND = (ET_o x PLANT FACTOR) x AREA x 0.623

For this equation use ET_o values in inches. The Plant Water Use Factor represents the percent of ET_o that is needed by the plant (**TABLE 6**). This is determined by the type of plant — high, medium, or low water use.

The irrigated area, expressed in square feet refers to how much area is planted. The conversion factor 0.623 converts inches into gallons. In the examples shown (**Sample Demand Worksheets for Tucson and Phoenix- pages 25 and 26**), the plants require approximately 26 percent of ET_o— the high range of low water use.

These plant water use factors approximate what is needed to maintain plant health and acceptable appearance. Specific plant values (coefficients) for landscape plants are not available. Irrigation experience tells us where plants fall within each category.

Grouping plants with similar water requirements into separate areas simplifies the system by making the amount of water needed to maintain those plants easier to calculate.

Consult the Arizona Department of Water Resources *Low Water Use/Drought Tolerant Plant Lists* at www.water.az.gov to determine the approximate water requirement of landscape plants. Or, consult your local Cooperative Extension office for irrigation requirements for plants common to your area.

**TABLE - 6
PLANT WATER USE**

PLANT TYPE	PERCENT RANGE	
	High	Low
Low Water Use	0.26	0.13
Medium Water Use	0.45	0.26
High Water Use	0.64	0.45

METHOD 2: Is used to determine demand for **established** landscapes and is based on actual water use. Use your monthly water bills to roughly estimate your landscape water demand.

With this method we assume that during the months of December, January and February, most of the water is used indoors and that there is very little landscape watering. *(If you irrigate your landscape more than occasionally during these months use Method 1.)*

To use this method average December, January, and February water use. Many water companies measures water in ccfs (100 cubic feet).

SAMPLE MONTHLY DEMAND WORKSHEET (Method 1) – Tucson

New or Established Landscapes, Irrigated Area = 450 Square Feet, Plant Factor = .26 Low Water Use

	A	B	C	D	E	F
Follow Instructions A through F for each month.	From Appendix J enter the E to amount in inches for each month.	From Table - 6 Enter the plant demand according to its water needs.	Multiply "A" by "B" to obtain plant water needs in inches.	Multiply "C" By 0.623 to convert inches to gallons per square foot.	Enter the total square footage of landscaping.	Multiply "E" by "D." This is your total landscaping demand in gallons
January	2.52	.26	.66	.41	450	185
February	3.19	.26	.83	.52	450	234
March	5.07	.26	1.32	.82	450	369
April	6.82	.26	1.77	1.11	450	495
May	8.61	.26	2.24	1.40	450	630
June	9.59	.26	2.49	1.55	450	698
July	8.95	.26	2.33	1.45	450	653
August	7.75	.26	2.02	1.26	450	567
September	6.68	.26	1.74	1.08	450	486
October	4.96	.26	1.29	.80	450	360
November	3.02	.26	.79	.49	450	221
December	2.16	.26	.56	.35	450	158
Totals	69.22		18.04			5056

SAMPLE DEMAND WORKSHEET (Method 1) – Phoenix

New or Established Landscapes, Irrigated Area = 450 Square Feet, Plant Factor = .26 Low Water Use

A	B	C	D	E	F	
Follow instructions A through F for each month.	From Appendix J enter the E to amount in inches for each month.	From Table - 6 enter the plant demand according to its water needs.	Multiply "A" by "B" to obtain plant water needs in inches.	Multiply "C" By 0.623 to convert inches to gallons per square foot.	Enter the total square footage of landscaping.	Multiply "E" by "D." This is your total landscaping demand in gallons
January	2.38	.26	.62	.39	450	176
February	2.87	.26	.75	.47	450	212
March	4.66	.26	1.21	.75	450	338
April	6.38	.26	1.66	1.03	450	464
May	8.71	.26	2.26	1.41	450	635
June	9.39	.26	2.44	1.52	450	684
July	9.02	.26	2.35	1.46	450	657
August	8.28	.26	2.15	1.34	450	603
September	6.60	.26	1.72	1.07	450	482
October	4.59	.26	1.19	.74	450	333
November	2.75	.26	.72	.45	450	203
December	2.24	.26	.58	.36	450	162
Totals	67.87		17.65			4,949

Again, we assume that there is little or no outside irrigation occurring in the winter months and indoor use remains relatively stable throughout the year. In the following example, the combined average winter monthly use is 9 ccf. Subtract the winter average monthly use from each month's combined use (from your water bill) and get a rough estimate of monthly landscape water use. To convert ccfs to gallons, multiply by 748.

A worksheet has been provided (Worksheet #3) in Appendix G to calculate your monthly demand if using Method 2.

SAMPLE MONTHLY DEMAND (Method 2)
Established Landscapes - All Locations
Average Winter Use = 9 CCF Household Size = 3

M o n t h	Monthly Use in CCF	Average Winter Use in CCF	Landscape Use in CCF	Convert CCF to Gallons	Landscape Use in Gallons
January	7	9	0	748	0
February	11	9	2	748	1496
March	13	9	4	748	2992
April	15	9	6	748	4488
May	18	9	9	748	6732
June	19	9	10	748	7480
July	18	9	9	748	6732
August	15	9	6	748	4488
September	14	9	5	748	3740
October	12	9	3	748	2244
November	10	9	1	748	748
December	9	9	0	748	0
Total	161		55		41,140

Calculate storage and municipal water requirement

Use a “checkbox” method to determine the amount of irrigation water available from water harvesting and the amount of municipal water needed — in case there is not enough stored rainwater in year one to supply the irrigation needs. This example is based on the supply and demand numbers from the Sample Supply and Demand Worksheets for Tucson pages 22 and 25.

SAMPLE WORKSHEET
MONTHLY STORAGE and MUNICIPAL USE

Month	Yield Gallons	Demand Storage	Cumulative Storage Gallons (yield demand)	Municipal Use
Year 1				
January	555	185	370	0
February	493	234	629	0
March	454	369	714	0
April	157	495	376	0
May	135	630	0	119
June	135	698	0	682
July	1161	653	0	174
August	1287	567	546	0
September	813	486	873	0
October	678	360	1191	0
November	376	221	1346	0
December	578	158	1766	0
Year 2				
January	555	185	2136	0
February	493	234	2395	0
March	454	369	2480	0
April	157	495	2142	0
May	135	630	1647	0
June	135	698	1084	0
July	1161	653	1592	0
August	1287	567	2312	0
September	813	486	2639	0
October	678	360	2957	0
November	376	221	3112	0
December	578	158	3532	0

For simplicity, the calculations are done on a monthly basis. However, in reality the amount of water available fluctuates on a daily basis.

The “Storage” column is *cumulative* and refers to what is actually available in storage. A given month's storage is calculated by adding the previous month's storage to the previous month's yield, minus the current month's demand. If the remaining amount is positive, it is placed in the Cumulative Storage column for the current month. This number is then added to the next month's yield to provide for the next month's demand.

If the amount of water available is negative, that is, if the demand is greater than the supply of stored water, this number is placed in the Municipal Use column. This indicates the amount of supplemental water needed to satisfy irrigation water demand for that month. During the first year there will be a *deficit* of harvested water because the year begins with an empty storage container.

However, beginning with Year 2 the storage has built up and there will always be enough harvested water for this landscape unless a drought occurs. The reason for this is that the winter rainwater is not all used up in winter when evapotranspiration rates are low, so this water can be saved for the “leaner” summer months. You will notice in the sample worksheet (**Monthly Storage and Municipal Use**) that each year the overall storage numbers will increase slightly because supply will likely exceed demand.

To determine storage, find the highest number in the Store column in the Monthly Storage and Municipal Use Worksheet for Year 2. This would be the maximum storage requirement. In this example, December will be the month with the most water — 3532 gallons. You will need approximately a 3600 gallon storage capacity to be self-sufficient using harvested water.

The worksheets are for determining potential storage capacity, they are not for weather prediction. Weather may vary from the average at any time. Each site presents its own set of supply and demand amounts. Some water harvesting systems may always provide enough harvested water, some may provide only part of the demand. Remember that the supply will fluctuate from year to year depending on the weather and on which month the rainfall occurs. Demand may increase when the weather is hotter than normal and will increase as the landscape ages and plants get larger. Demand is also high for new landscapes since establishing new plants requires more frequent irrigation.

Final design and construction — Use your site analysis information and your potential supply and demand calculations to size and locate catchment areas (blank worksheets to calculate the supply and demand for your site (Method 1 and Method 2) are provided in Appendices F and G.

Roofs or shade structures can be designed or retrofitted to maximize the size of the catchment area. For new construction, design the landscape in conjunction with your home to maximize the size of the catchment area (e.g. roof, shade structure, patios

and walkways) to accommodate the maximum landscape water requirement dictated by your landscape design. If you cannot do this you may want to reduce plant water demand by either using fewer plants or selecting plants with lower water use requirements.

If you are planning a new landscape, create a landscape that can live on the amount of water harvested from the existing roof catchment area. This can be accomplished by careful plant selection and control of the number of plants used. For the most efficient use of the harvested water, group plants with similar water requirements together. Remember that new plantings, even native plants, require special care and will need supplemental irrigation during the establishment period which can range between one and three years (use the supply and demand calculations to determine this). Use gutters and downspouts to convey the water from the roof to the storage area. Consult the guidelines (Appendix A) for tips on selecting and installing gutters and downspouts.

Size your storage container(s) large enough to hold your calculated supply. Provide for distribution to all planted areas. Water collected from any catchment area can be distributed to any landscaped area; however, to save effort and money, locate storage close to plants needing water and higher than the planted area to take advantage of gravity flow.

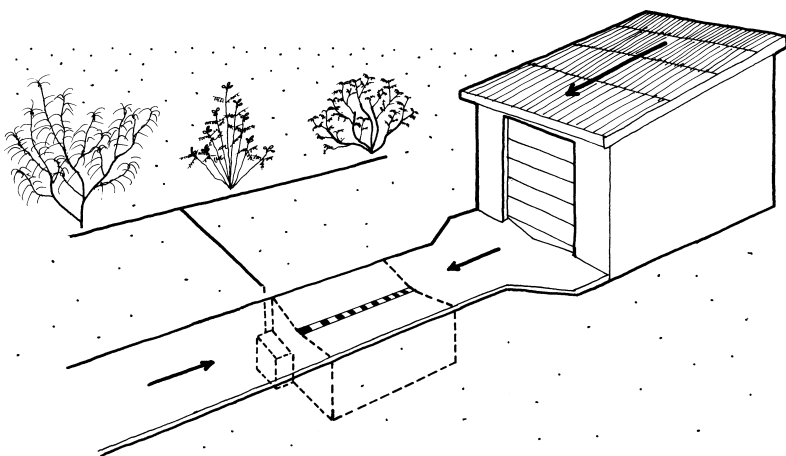

Roof catchment with sloping driveway, french drain and underground storage.

Pipes (Schedule 40 PVC), hoses, channels, and drip systems can distribute water to where it is needed. If you do not have gravity flow or if you are distributing through a drip system you will need to use a small 1/2 HP pump to move the water through the lines. Select drip irrigation system filters with 200 mesh screens. The screen should be cleaned regularly.

If there is not enough water harvested for landscape watering, there are several options:

- Increase the catchment area,
- Reduce the amount of landscaped area,
- Reduce the plant density,
- Replace the plants with lower water use plants,
- Use mulch to reduce surface evaporation,
- Use municipal water, or
- Use greywater- Household water collected from bathroom sinks (not the kitchen sink), showers, and washing machines for reuse as landscape irrigation¹.

¹ In Arizona residential graywater systems that produce less than 400 gallons per day no longer require a permit from the Arizona Department of Environmental Quality (ADEQ). ADEQ does have a general use permit for graywater that requires homeowners to follow best management practices to comply with Arizona's rules for graywater use, for health and safety reasons. (For further information see page 53).

In addition, you should consult your local jurisdictions (county, city or town) for any additional regulations they may have.

APPENDIX A - GUIDELINES

Gutters

- Select gutters that are 5 inches wide.
- Select galvanized steel (26 gauge minimum) or aluminum (.025 inch minimum) gutters.
- Slope gutters 1/16" per 1' of gutter, to enhance flow.
- Use an expansion joint at the connection, if a straight run of gutter exceeds 40 feet.
- Keep the front of the gutter one-half inch lower than the back.
- Provide gutter hangers every 3 feet.
- Do not exceed 45 degree angle bends in horizontal pipe runs.
- Select elbows in 45, 60, 75, or 90 degree sizes.

Downspouts

- Space downspouts a minimum of 20 feet apart, a maximum of 50 feet apart.
- Provide 1 square inch of downspout area, for every 100 square feet of roof area.
- Select downspouts in different configurations -- square, round, and corrugated round, depending on your needs.
- Use 4-inch diameter Schedule 40 PVC to convey water to the storage container or filter.

**APPENDIX B - ROOF WASHING SYSTEM
FIRST FLUSH DEVICE**

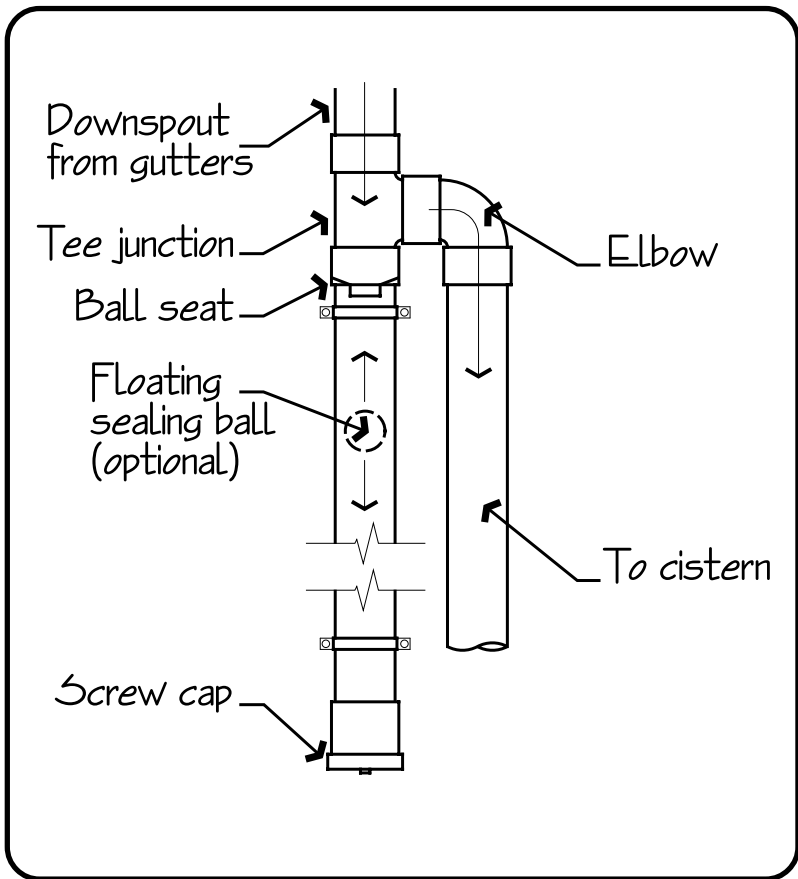

Source: *Forgotten Rain - Rediscovering Rainwater Harvesting*, 2003.

APPENDIX C - RESIDENTIAL CISTERN DETAIL

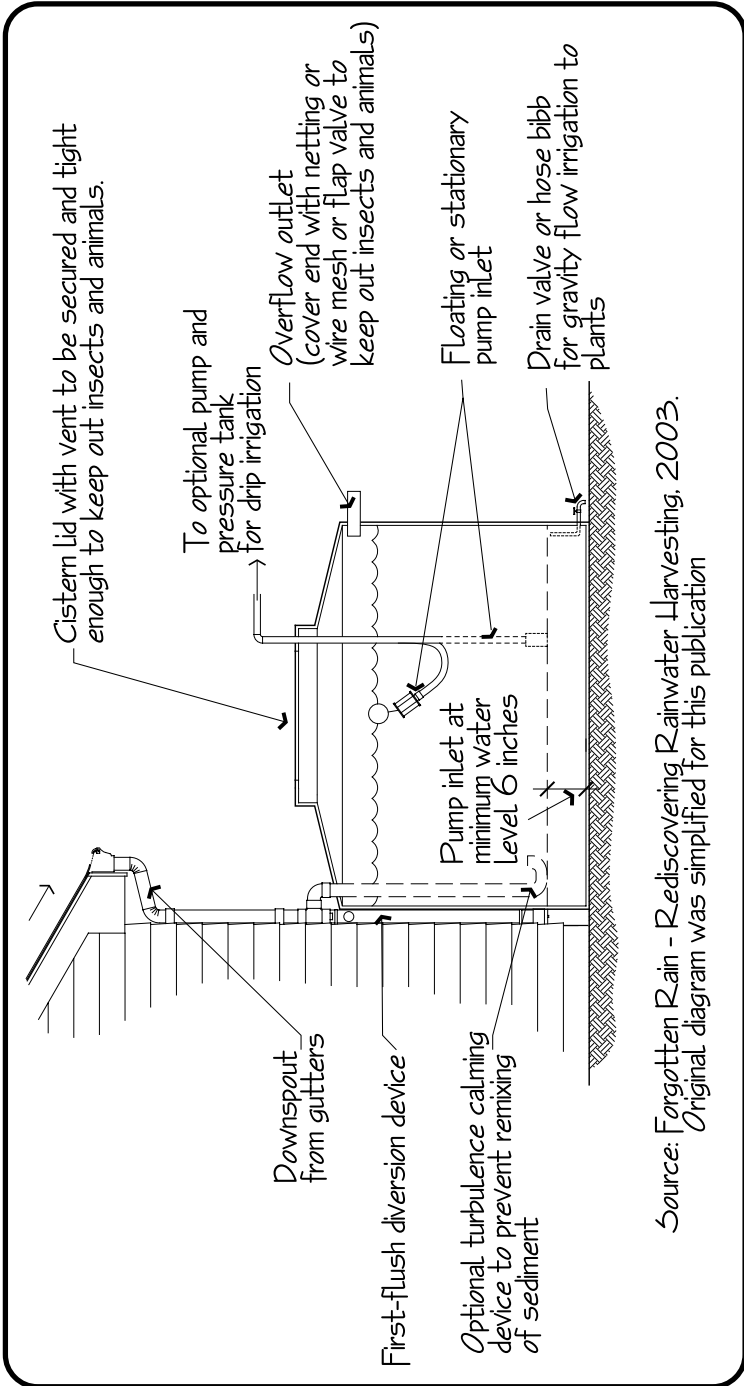

Source: *Forgotten Rain - Rediscovering Rainwater Harvesting, 2003.*
 Original diagram was simplified for this publication

APPENDIX D CULVERT CISTERN DETAIL

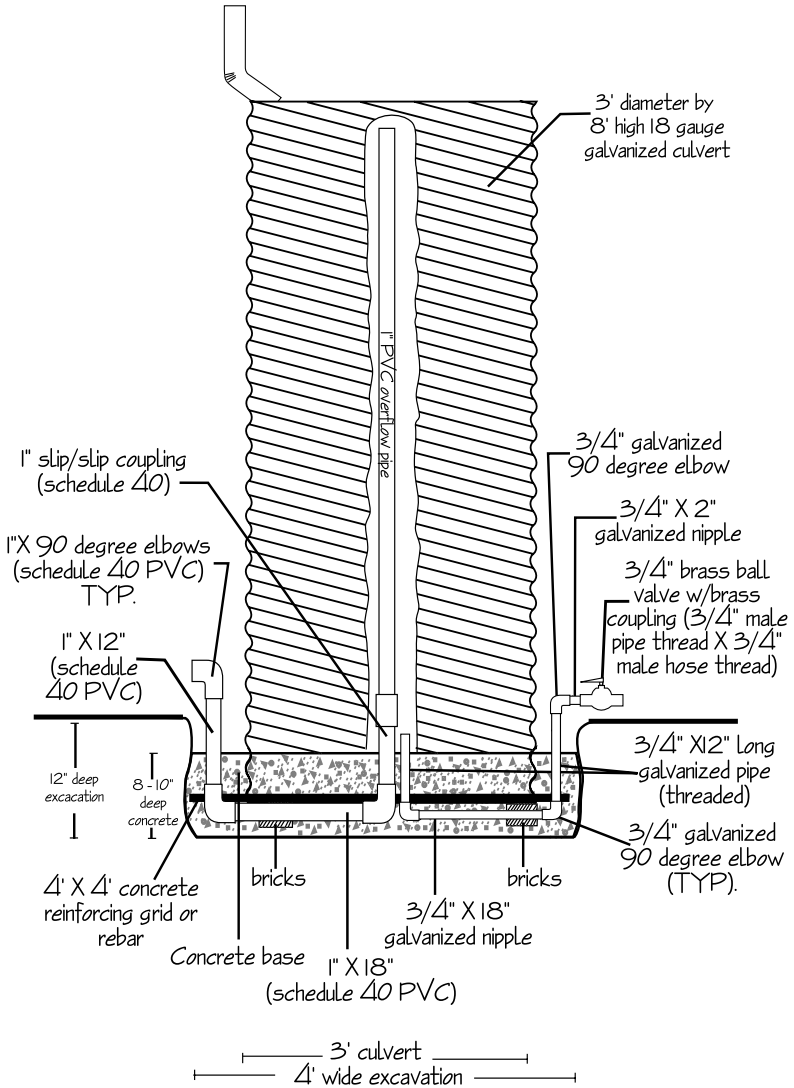

Source: Scott Calhoun, ACNP and Josephine Thomason

Culvert Cistern Components List (refer to diagram)

QTY

- 1 - can PVC primer
- 1 - can PVC cement (glue)
- 1 - roll of Teflon tape or can of plumbers putty
- 2 - 2" x 4" x 8' pieces of lumber
- 1 - 3' diameter by 8' high 18 gauge galvanized culvert
- 25 - bags of concrete (60 lbs. each)
- 1 - 4' x 4' concrete reinforcing grid or rebar
- 4 - bricks
- 1 - gallon asphalt emulsion, for drinking water use
Thruoseal, or elastomeric paint instead
- 2 - 3/4" x 12" long galvanized pipes (threaded)
- 3 - 3/4" galvanized 90 degree elbows
- 1 - 3/4" x 18" galvanized nipple
- 1 - 3/4" x 2" galvanized nipple
- 1 - 3/4" brass ball valve w/brass coupling
(3/4" male pipe thread x 3/4" male hose thread)
- 2 - 1" x 10' long (schedule 40 PVC)
- 3 - 1" x 90 degree elbows (schedule 40 PVC)
- 1 - 1" slip/slip coupling (schedule 40)

Cistern Top - for a 3 foot diameter cistern

The least expensive solutions to covering the cistern are to use either floating pool cover material (4' x 4' piece cut to size), or to drape a (5' x 5') piece of window screening or shade cloth over the top and secure it by wrapping a piece of wire around the cover material, securing it to the cistern. For a more secure and aesthetically pleasing cistern top use galvanized sheet metal.

Components List for Galvanized Top

- 18 gauge galvanized sheet metal cut to size and shape
- 3 - carriage bolts (long enough to go through the holes in the eye bolts)
- 3 - wing nuts to fit carriage bolts
- 3 - eye bolts
- 6 - washers and nuts to fit eye bolts
- 2 - lengths of pipe insulation (approximately 6' each)

Water Harvesting Culvert Cistern

Instructions:

- 1) Determine how you will cover the cistern, if using a permanent metal cover, see Culvert Top Directions, Option 3 - before proceeding as 3 holes must be drilled in the culvert prior to installation.
- 2) Starting from the bottom paint the sides (inside and out) with asphalt emulsion 12 inches up from the bottom of the culvert. If water is to be used for non-irrigation purposes such as for drinking, or stock water, Thorough-Seal or elastomeric paint should be used rather than asphalt emulsion.
- 3) Using pipe wrenches and Teflon tape, assemble 3/4" galvanized pipes for the U-shaped assembly shown in the diagram.
- 4) Glue together the PVC overflow assembly as shown in the diagram.
- 5) Excavate a square hole 4 feet wide by 12 inches deep.
- 6) Place bricks (to hold up the grid or rebar) and RE grid in hole and level.
- 7) Slip U-shaped galvanized supply assembly and U-shaped PVC overflow assembly under and through the grid. Wire the two assemblies together so they stand upright.
- 8) Mix cement and fill hole with 8-10 inches of concrete.
- 9) Taking care not to disturb the supply and overflow pipes, stand the culvert up in the wet cement centering it in the hole.
- 10) Using two 2 x 4 s and a level, make sure the culvert is plumb, adjusting as needed using the 2 x 4's as braces.
- 11) When the cement has dried, glue the upper portion of the overflow pipe into the slip/slip fitting near the bottom of the culvert.
- 12) Direct overflow outlet away from the building.

Culvert Top Directions:

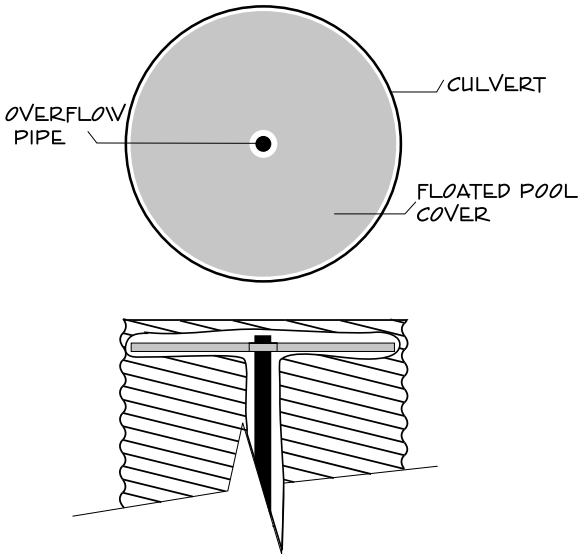

OPTION 1

Option 1 : Floating Cover - cut a piece of floated pool cover material to fit the inside diameter of the culvert. Place the cover inside the top of the culvert cutting a hole for the overflow pipe to pass through. The hole should be slightly larger than the overflow pipe to allow the cover to raise and lower easily, depending on the water level inside the cistern.

Option 2 : Screen Cover - cut a piece of window screening or shade cloth approximately two feet wider than the diameter of the cistern, center the screening or shade cloth on the cistern top and fold edges down along the outside of the cistern and secure it by wrapping a length of wire around the outside of the cistern, catching all the edges of the screen or shade cloth and twist the ends of the wire together to assure a tight fit.

Option 3 : Metal Top - drill three holes evenly spaced around the top of the cistern, approximately one inch from the top edge. Put the eyebolts through the predrilled holes from the outside of the cistern and secure in place with the nuts and washers inside the cistern. One washer should be on the inside of the tank, the other on the outside of the tank.

After the tank is installed, put the pipe insulation around the edge of the tank to form a seal.

Cut a piece of 18 gauge sheet metal approximately one inch larger than the top of the cistern all the way around (2 inches larger in diameter).

Drill holes in the sheet metal after the tank is in place to insure the holes are lined up with the eye bolts. Next put the carriage bolts through the holes in the top and into the eyebolts and secure with a wing nut.

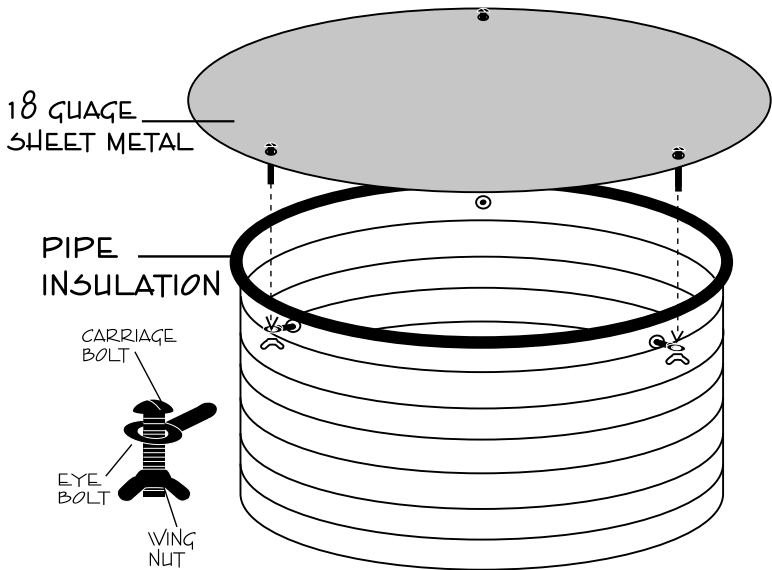

OPTION 3

APPENDIX E – Worksheet 1: Supply Calculations

	A	B	C	D	E	F
Follow instructions A through F for each month.	From Appendix I enter the rainfall amount in inches for each month.	Multiply "A" by 0.623 to convert inches to gallons per square foot.	Enter the square footage of the catchment surface.	Multiply "B" By "C." This is the gross gallons of rainfall per month	Enter the runoff coefficient for your catchment surface (page 14)	Multiply "D" by "E." This is the total monthly yield of harvested water in gallons
January						
February						
March						
April						
May						
June						
July						
August						
September						
October						
November						
December						
Totals						

APPENDIX F - Worksheet 2: Demand Calculations (METHOD 1)

	A	B	C	D	E	F
Follow the lettered instructions for each month.	From Appendix J enter the Eto amount for your locale in inches for each month.	From Table - 6, page 24 enter the plant demand according to its water needs.	Multiply "A" by "B" to obtain plant water needs in inches.	Multiply "C" By 0.623 to convert inches to gallons per square foot.	Enter the total square footage of landscaping.	Multiply "E" by "D." This is your total landscaping demand in gallons
January						
February						
March						
April						
May						
June						
July						
August						
September						
October						
November						
December						
Totals						

APPENDIX G - Worksheet #3
Demand Calculations (Method 2)

Month	Monthly Use in CCF from water bill	Average Winter Use in CCF from water bill	Landscape Use in CCF from Worksheet #2	Convert CCF to Gallons multiply by	Landscape Use in Gallons
January				748	
February				748	
March				748	
April				748	
May				748	
June				748	
July				748	
August				748	
September				748	
October				748	
November				748	
December				748	

APPENDIX H - Worksheet 4: Storage and Municipal Use Calculations

Month	Yield Gallons	Demand Storage	Cumulative Storage Gallons (yield-demand)	Municipal Use
Year 1 January				
February				
March				
April				
May				
June				
July				
August				
September				
October				
November				
December				
Year 2 January				
February				
March				
April				
May				
June				
July				
August				
September				
October				
November				
December				

APPENDIX I

INCHES OF AVERAGE MONTHLY RAINFALL FOR ARIZONA CITIES AND TOWNS

	Bullhead City	Casa Grande	Chandler	Douglas	Flagstaff	Gila Bend	Holbrook	Kingman
Jan	0.95	0.77	1.10	0.75	2.18	0.62	0.71	1.23
Feb	0.99	0.83	0.99	0.64	2.56	0.87	0.66	1.10
Mar	0.93	0.99	0.94	0.46	2.62	0.72	0.72	1.31
Apr	0.17	0.28	0.32	0.20	1.29	0.20	0.37	0.47
May	0.08	0.19	0.17	0.33	0.80	0.15	0.38	0.31
Jun	0.01	0.10	0.15	0.63	0.43	0.04	0.20	0.19
July	0.29	0.80	0.50	3.14	2.40	0.76	1.17	0.98
Aug	0.68	1.97	0.62	2.88	2.89	1.20	1.51	1.41
Sep	0.44	0.82	0.53	1.63	2.12	0.53	1.18	0.66
Oct	0.37	0.77	0.84	1.30	1.93	0.52	1.07	0.81
Nov	0.41	0.74	0.67	0.74	1.86	0.56	0.66	0.71
Dec	0.52	0.96	0.76	1.06	1.83	0.84	0.57	0.82
Annual	5.84	9.22	7.59	13.76	22.91	7.01	9.20	10.00

Precipitation
Normal for Period 1971 - 2000 (National Weather Service)

INCHES OF AVERAGE MONTHLY RAINFALL FOR ARIZONA CITIES AND TOWNS

	Marana	Mesa	Nogales	Page	Parker	Payson	Phoenix	Pinetop	Prescott	Safford
Jan	1.09	1.01	1.31	0.61	0.87	2.33	0.83	2.00	1.58	0.74
Feb	1.25	0.99	1.09	0.48	0.70	2.34	0.77	1.90	1.87	0.78
Mar	0.79	1.19	1.00	0.66	0.65	2.68	1.07	1.63	1.91	0.61
Apr	0.46	0.33	0.49	0.50	0.17	1.15	0.25	0.88	0.76	0.22
May	0.17	0.17	0.32	0.40	0.09	0.66	0.16	0.83	0.64	0.27
Jun	0.14	0.06	0.54	0.14	0.02	0.37	0.09	0.72	0.40	0.31
Jul	1.38	0.89	4.27	0.58	0.27	2.42	0.99	2.82	2.87	1.45
Aug	2.17	1.14	4.24	0.69	0.61	2.97	0.94	3.72	3.28	1.72
Sep	0.55	0.89	1.68	0.66	0.57	1.81	0.75	2.59	2.07	1.12
Oct	0.73	0.81	1.84	0.99	0.32	1.89	0.79	1.84	1.28	1.10
Nov	0.44	0.77	0.78	0.56	0.33	1.70	0.73	1.74	1.25	0.56
Dec	1.15	0.98	1.47	0.48	0.57	1.75	0.92	1.93	1.28	0.91
Annual	10.32	9.23	19.03	6.75	5.17	22.07	8.29	22.60	19.19	9.79

Precipitation
Normal for Period 1971 - 2000 (National Weather Service)

INCHES OF AVERAGE MONTHLY RAINFALL FOR ARIZONA CITIES AND TOWNS

	Scottsdale	Sierra Vista	Springerville	Tempe	Tuba City	Tucson	Willcox	Williams	Yuma
Jan	1.01	1.19	0.50	1.01	0.55	0.99	1.11	2.08	0.38
Feb	1.06	0.65	0.50	1.04	0.52	0.88	0.95	2.37	0.28
Mar	0.96	0.44	0.49	1.15	0.59	0.81	0.68	2.32	0.27
Apr	0.35	0.36	0.27	0.25	0.27	0.28	0.25	1.00	0.09
May	0.17	0.26	0.45	0.21	0.32	0.24	0.35	0.80	0.05
Jun	0.11	0.38	0.53	0.07	0.17	0.24	0.40	0.48	0.02
Jul	0.99	3.01	2.52	0.89	0.66	2.07	2.36	2.54	0.23
Aug	1.05	3.85	3.11	1.20	0.69	2.30	2.59	3.01	0.61
Sep	0.87	1.29	1.49	0.86	0.98	1.45	1.27	1.73	0.26
Oct	0.97	1.16	1.08	0.85	0.85	1.21	1.36	1.77	0.26
Nov	0.88	0.45	0.57	0.80	0.43	0.67	0.73	1.75	0.14
Dec	0.99	0.98	0.48	1.03	0.32	1.03	1.30	1.52	0.42
Annual	9.41	14.02	11.99	9.36	6.35	12.17	13.35	21.37	3.01

Precipitation

Normal for Period 1971 - 2000 (National Weather Service)

APPENDIX J

INCHES OF AVERAGE MONTHLY EVAPOTRANSPIRATION FOR ARIZONA CITIES AND TOWNS

	Bullhead	Casa Grande	Chandler	Douglas	Flagstaff	Gila Bend	Holbrook	Kingman
Jan	2.92	2.31	2.38	3.16	1.61	2.66	1.48	2.82
Feb	3.48	3.16	2.87	3.58	1.74	3.26	2.15	3.37
Mar	5.68	5.17	4.66	5.07	2.85	4.75	3.27	4.40
Apr	7.56	7.24	6.38	6.68	4.24	6.99	4.83	6.03
May	9.78	9.55	8.71	8.67	5.79	9.24	6.87	7.87
Jun	9.97	10.28	9.39	9.72	7.09	10.18	8.09	9.40
Jul	9.24	10.00	9.02	8.10	6.46	9.78	8.10	9.56
Aug	8.35	8.75	8.28	7.31	5.63	8.76	7.20	8.44
Sep	6.63	7.00	6.60	6.58	4.64	6.95	5.81	6.89
Oct	5.33	5.18	4.59	5.41	3.21	5.40	4.06	4.96
Nov	3.67	3.00	2.75	3.64	2.13	3.36	2.34	3.53
Dec	3.30	2.14	2.24	2.82	1.74	2.48	1.48	2.48
Total	75.91	73.78	67.87	70.74	47.13	73.81	55.69	69.74

ETos (Standardized Ref. Evapotranspiration)

Yuma, Bullhead, Tucson, Phoenix computed by AZMET, Nogales, Prescott, Kingman, Williams, Payson estimated using Yitayew*
 Flagstaff: computed from local weather data

* Yitayew, M. 1990. Reference Evapotranspiration Estimates for Arizona. Tech. I Bull. 266. Agr.Exp.Stn.Col. of Agr. University of Arizona

INCHES OF AVERAGE MONTHLY EVAPOTRANSPIRATION FOR ARIZONA CITIES AND TOWNS

	Marana	Mesa	Nogales	Page	Parker	Payson	Phoenix	Pinetop	Prescott	Safford
Jan	3.16	2.38	3.16	1.58	2.83	2.04	2.38	1.58	1.89	2.69
Feb	3.72	2.87	3.68	2.25	3.51	2.35	2.87	1.95	2.86	3.41
Mar	5.70	4.66	4.62	3.73	5.69	3.16	4.66	2.82	3.73	5.48
Apr	7.44	6.38	6.25	5.81	8.07	4.73	6.38	4.19	5.38	7.52
May	9.72	8.71	8.10	8.10	10.34	6.64	8.71	5.63	6.08	9.63
Jun	10.59	9.39	9.07	9.72	11.12	8.21	9.39	6.47	9.07	10.31
Jul	9.53	9.02	7.98	9.45	10.85	7.87	9.02	6.08	8.67	9.18
Aug	8.26	8.28	7.31	8.44	9.59	6.53	8.28	5.07	6.98	7.42
Sep	7.28	6.60	6.47	6.58	7.70	5.70	6.60	4.40	6.68	6.35
Oct	5.94	4.59	5.30	4.51	5.81	3.95	4.59	3.61	4.51	6.08
Nov	3.97	2.75	3.53	2.45	3.64	2.66	2.75	2.34	2.99	3.24
Dec	2.79	2.24	2.71	1.48	2.26	1.92	2.24	1.47	2.15	2.38
Total	78.10	67.87	68.19	64.10	81.41	55.77	67.87	45.59	60.99	73.69

ETos (Standardized Ref. Evapotranspiration)

Yuma, Bullhead, Tucson, Phoenix computed by AZMET, Nogales, Prescott, Kingman, Williams, Payson estimated using Yitayew*
 Flagstaff: computed from local weather data

* Yitayew, M. 1990. Reference Evapotranspiration Estimates for Arizona. Tech. I Bull. 266. Agr.Exp.Stn.Col. of Agr. University of Arizona

INCHES OF AVERAGE MONTHLY EVAPOTRANSPIRATION FOR ARIZONA CITIES AND TOWNS

	Scottsdale	Sierra Vista	Springerville	Tempe	Tuba City	Tucson	Willcox	Williams	Yuma
Jan	2.38	2.80	1.48	2.38	1.36	2.52	2.45	1.36	3.27
Feb	2.87	3.21	1.95	2.87	1.95	3.19	3.04	1.65	3.79
Mar	4.66	4.60	2.82	4.66	3.27	5.07	4.96	2.82	5.67
Apr	6.38	6.21	4.07	6.38	4.62	6.82	6.66	4.07	7.24
May	8.71	7.97	5.29	8.71	6.98	8.61	8.26	5.30	9.16
Jun	9.39	9.04	6.46	9.39	8.42	9.59	9.23	7.12	10.21
Jul	9.02	7.74	6.08	9.02	8.10	8.95	8.35	6.75	10.50
Aug	8.28	7.07	5.52	8.28	7.31	7.75	6.94	5.63	9.67
Sep	6.60	6.21	4.40	6.60	6.03	6.68	5.99	4.94	7.92
Oct	4.59	4.37	3.61	4.59	4.06	4.96	4.77	3.61	5.87
Nov	2.75	3.17	2.01	2.75	2.23	3.02	3.09	2.00	3.80
Dec	2.24	2.58	1.36	2.24	1.25	2.16	2.19	1.70	3.10
Total	67.87	64.97	45.07	67.87	55.58	69.32	65.93	46.96	80.20

ETos (Standardized Ref. Evapotranspiration)

Yuma, Bullhead, Tucson, Phoenix computed by AZMET, Nogales, Prescott, Kingman, Williams, Payson estimated using Yitayew*
 Flagstaff: computed from local weather data

* Yitayew, M. 1990. Reference Evapotranspiration Estimates for Arizona. Tech. l Bull. 266. Agr.Exp.Stn.Col. of Agr. University of Arizona

APPENDIX K - WATER HARVESTING RELATED RESOURCES AND CONTACTS

PUBLICATIONS ADDRESSING WATER HARVESTING

FORGOTTEN RAIN REDISCOVERING RAINWATER HARVESTING, by Heather Kinkade-Levario, 2003
Distributed by Rock and Water- Phoenix, Arizona
www.forgottenrain.com.

RAINWATER HARVESTING FOR DRYLANDS, "A how-to book about welcoming rainwater into your life, landscape, and soil." by Brad Lancaster. Available Spring 2005.
www.harvestingrainwater.com

SECOND NATURE, Adapting LA's Landscape For Sustainable Living edited by Patrick Condon and Stacy Moriarty. Metropolitan Water District of Southern California, 1999. Concepts such as passive rainwater harvesting and multiuse landscaping for sustainability are presented. TREEPEOPLE, 12601 Mulholland Drive, Beverly Hills, CA 90210, <http://www.treepeople.org/trees>

TEXAS GUIDE TO RAINWATER HARVESTING, 2nd Ed., by Wendy Price Todd and Gail Vittori. Texas Water Development Board in cooperation with the Center for Maximum Potential Building Systems, 1997. Obtain a copy by writing to Conservation, Texas Water Development Board, PO Box 13231, Austin, TX 78711-3231. Easy to read, primer on water quality, descriptive and detailed manual on how to build water harvesting systems; includes glossary and reference section. Also available digitally at http://www.twdb.state.tx.us/assistance/conservation/AlternativeTechnologies/Rainwater_Harvesting/Rain.asp

THE SUSTAINABLE BUILDING SOURCE BOOK, City of Austin Environmental & Conservation Services Dept., Austin, TX, 1995. Comprehensive guidebook of materials and methods of building, including information on water harvesting; lists professional assistance, materials and systems, and general information. Order from: Austin Energy, 721 Barton Springs Rd., Austin, TX 78704, Phone: (512) 494-9400 Also available digitally at: <http://www.greenbuilder.com/sourcebook/Rainwater.html>

WEB SITES

A LANDSCAPER'S GUIDE TO MULCH by the Alameda County Waste Management Authority and the Alameda County Source Reduction and Recycling Board. 777 Davis Street, Suite 100, San Leandro, CA 94577. Email:

acwma@stopwaste.org.

Web: <http://www.stopwaste.org/>. Very good recycling site. Look around the site for other good information.

American Rainwater Catchment Systems Association, Good links and publications, especially the Forgotten Rain link. <http://www.arcsa-usa.org>

DESERT WATERS - From Ancient Aquifers to Modern Demands by Nancy R. Laney. Arizona-Sonora Desert Museum, 1998. A good short and concise publication on our water situation in the southwest with tips on how to reduce our water use. <http://www.desertmuseum.org/books/catalogue.html>

RAINWATER COLLECTION FOR THE MECHANICALLY CHALLENGED: http://www.rainwatercollection.com/rainwater_collection.html

STORMWATER AS A RESOURCE HOW TO HARVEST AND PROTECT A DRYLAND TREASURE by David Morgan and Sandy Trevathan. A brief, clear, and concise guide for harvesting rain and snow on your property.

On-line copy at http://www.nmenv.state.nm.us/swqbStorm_Water_as_a_Resource.pdf

Sustainability of semi-Arid Hydrology and Riparian Habitat, Check out the residential water conservation page. <http://www.sahra.arizona.edu/>

RELATED RESOURCES

Arizona Native Plant Society, Box 41206, Sun Station, Tucson, AZ 85717

Web: <http://aznps.org>

Bowers, Janice Emily. SHRUBS AND TREES OF THE SOUTHWEST DESERTS. Tucson: Southwest Parks and Monuments Association, 1993

Mielke, Judy. NATIVE PLANTS FOR SOUTHWESTERN LANDSCAPES, Austin: University of Texas Press, 1993

Nabhan, Gary Paul. GATHERING THE DESERT, Tucson: University of Arizona Press, 1985

Native Seeds/SEARCH, 526 N. 4th Ave., Tucson, AZ 85705, Phone: (520) 622-5591: open-pollinated, native edibles, both domesticated and wild. Free seed available for Native Americans

Tucson Audubon Society, 300 E. University Blvd., Suite 120, Tucson AZ 85705. Information on avian and riparian habitat restoration using water harvesting. Phone: (520) 206-9900

Wildlands Restoration, 2944 N. Castro, Tucson, AZ 85705, Phone: (520) 882-0969: Drought tolerant native seed source. Habitat restoration mixes, native grass mixes, wildflowers, butterfly mix and others.

WATER HARVESTING CLASSES

Dawn Southwest, <http://www.greenbuilder.com/dawn>, 520-624-1673

Pima County Cooperative Extension, classes are held state-wide, reservations required: Phone: (520) 626-5161

Sonoran Permaculture Guild, Water Harvesting Teachers and Consultants, <http://www.sonoranpermaculture.org>

GRAYWATER

CREATE AN OASIS WITH GREYWATER, Your Complete Guide to Choosing, Building and Using Greywater Systems 4th Ed. Art Ludwig, published by Oasis Design, 2000.
<http://www.oasisdesign.net/>

HOME USE OF GRAYWATER, RAINWATER CONSERVES WATER AND MAY SAVE MONEY, by Joe Gelt University of Arizona. <http://ag.arizona.edu/AZWATER/arroyo/071rain.html>

GRAYWATER GUIDELINES, by Val Little, Water Conservation Alliance of Southern Arizona (Water CASA).
<http://www.watercasa.org>

Rainwater Collection and Gray Water as Alternative Water Supply Sources. Many good links.
http://www.geckodance.com/Family_Focus/Rainwater_Collection.html

REGULATIONS:

USING GRAY WATER AT HOME, The Arizona Department of Environmental Quality's Guide to Complying with the New, Simplified Type 1 General Permit, August 2001-Publication No.C 01-06. www.azdeq.gov

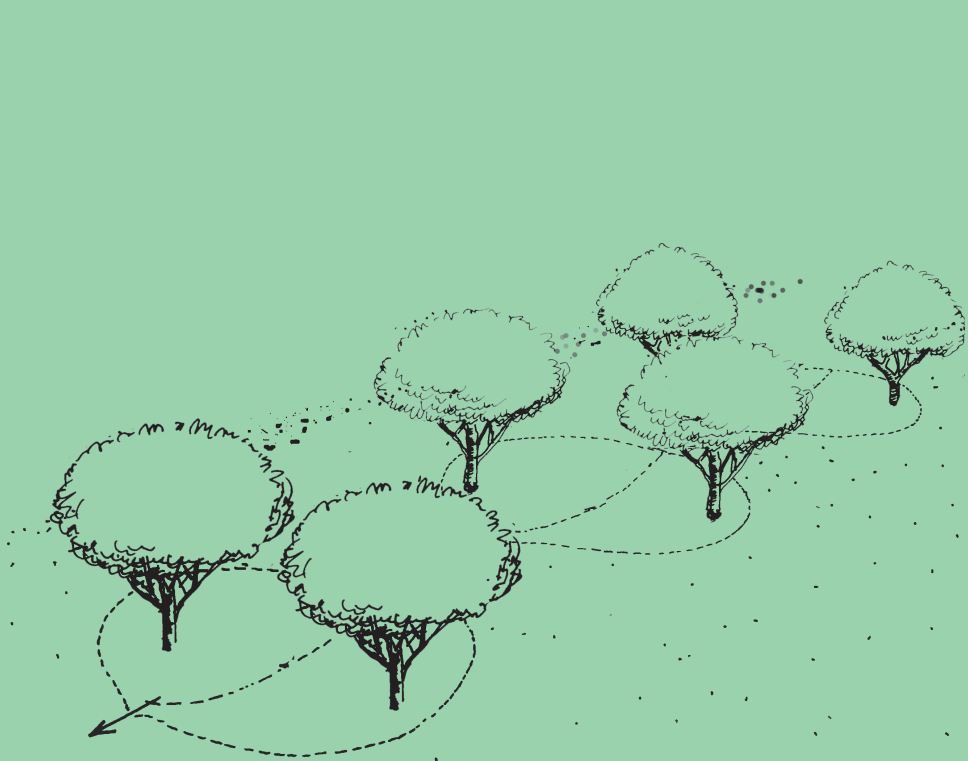

THE UNIVERSITY OF
ARIZONA®
COLLEGE OF AGRICULTURE
AND LIFE SCIENCES